

57

IMPRESSION

PAGE 128 - 134

FAMBRO®



NAME OF QUALITY INSTRUMENTS



Impression Trays For Crown & Bridge Work

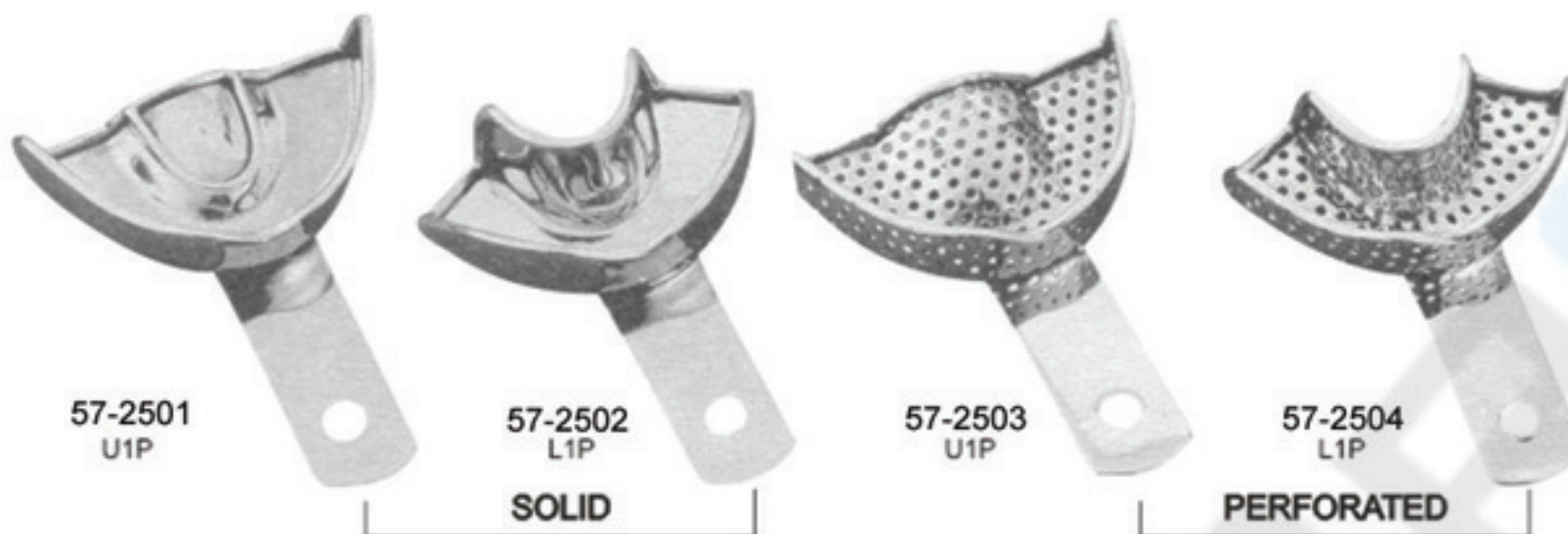

57-2501
U1P

57-2502
L1P

57-2503
U1P

57-2504
L1P

SOLID

PERFORATED



57-2505
Adjustable
Perforated



57-2506
Adjustable
Solid

57-2507
PERFORATED

57-2508
SOLID



57-2509-A
For upper right jaw
For lower left jaw

57-2509-B
For upper left jaw
For lower right jaw

- Available in 4 sizes
- 1.....44 mm
 - 2.....55 mm
 - 3.....60 mm
 - 4.....65 mm



57-2510-A
For upper right jaw
For lower left jaw

57-2510-B
For upper left jaw
For lower right jaw

- Available in 4 sizes
- 1.....44 mm
 - 2.....55 mm
 - 3.....60 mm
 - 4.....65 mm

Made of 18/8 Stainless Steel, Solid, Set of 10

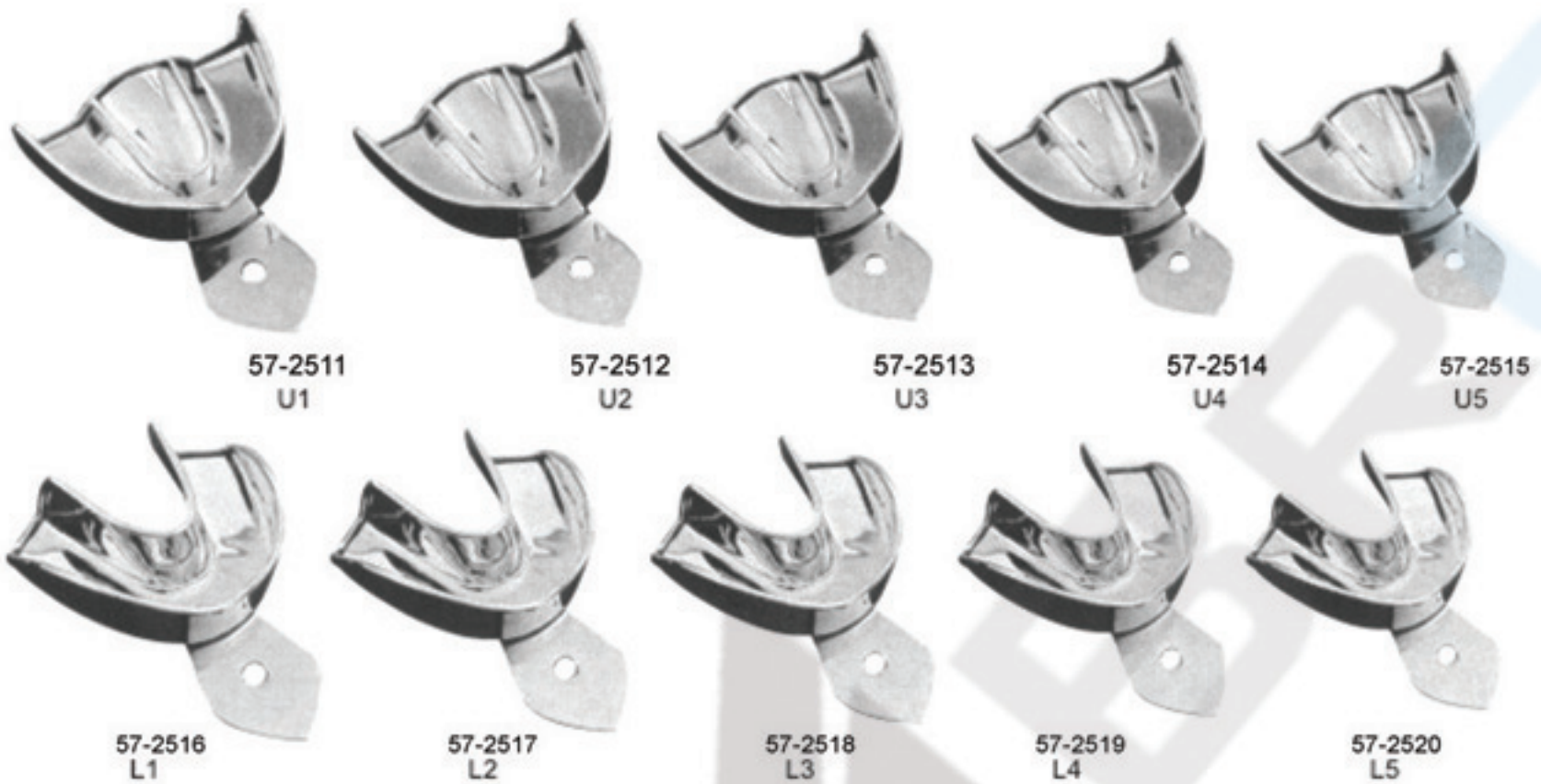

All The Above Impression Trays are Available in These 5 Sizes

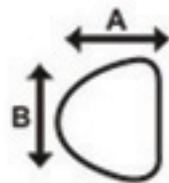

UPPER		U1	U2	U3	U4	U5
	A	62	60	53	54	52
B	83	75	73	69	68	

All Dimension are in mm

LOWER		L1	L2	L3	L4	L5
	A	63	61	57	60	53
B	82	81	78	74	71	

All Dimension are in mm



Perforated, Set of 10

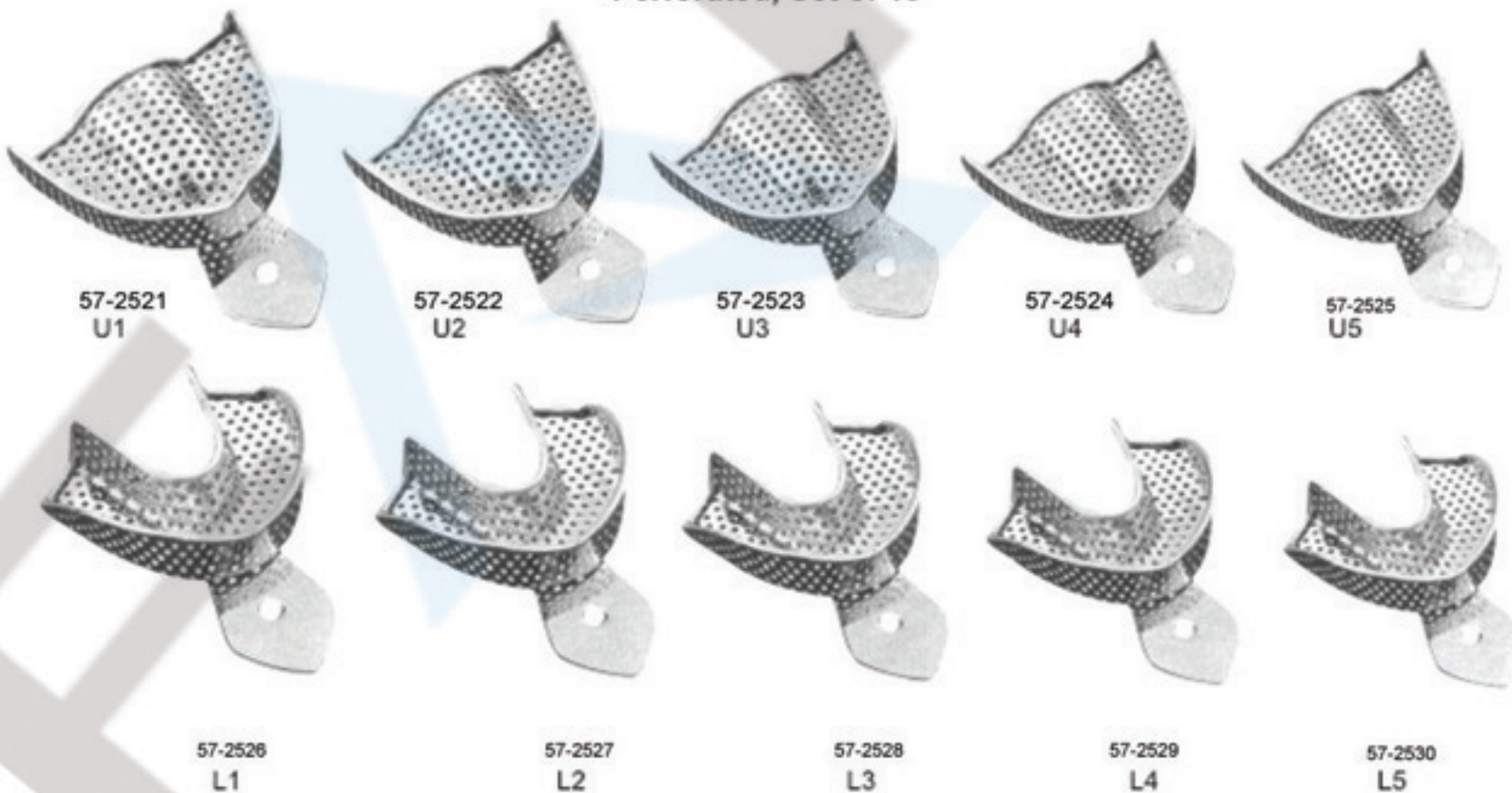

Made of 18/8 Stainless Steel, Solid Full Denture Set of 8

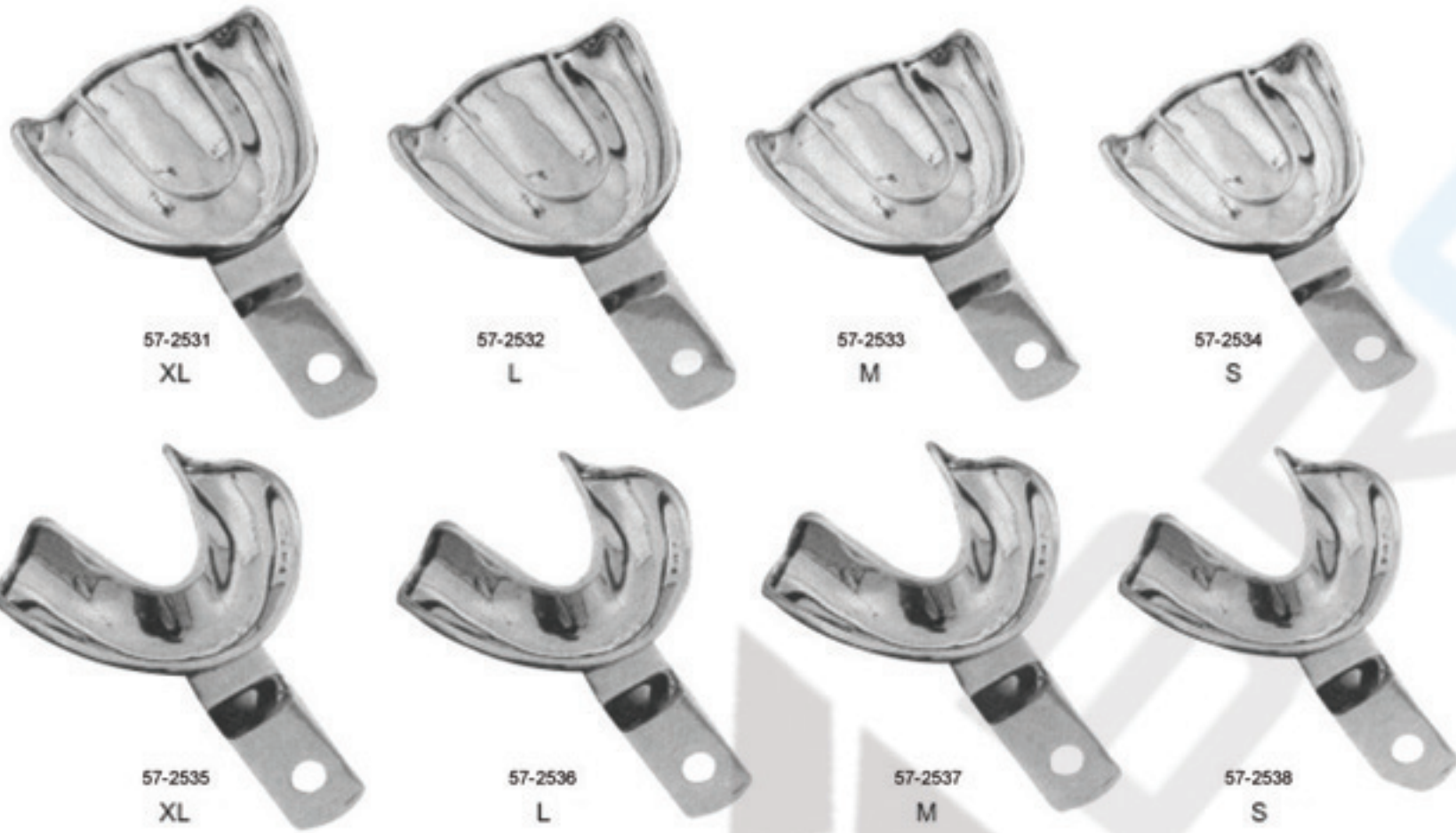

All The Above Impression Trays are Available in These 4 Sizes

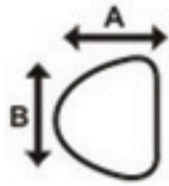

UPPER		XL	L	M	S
	A		70	67	64
B		79	76	70	73

All Dimension are in mm

LOWER		XL	L	M	S
	A		64	64	60
B		86	70	73	70

All Dimension are in mm

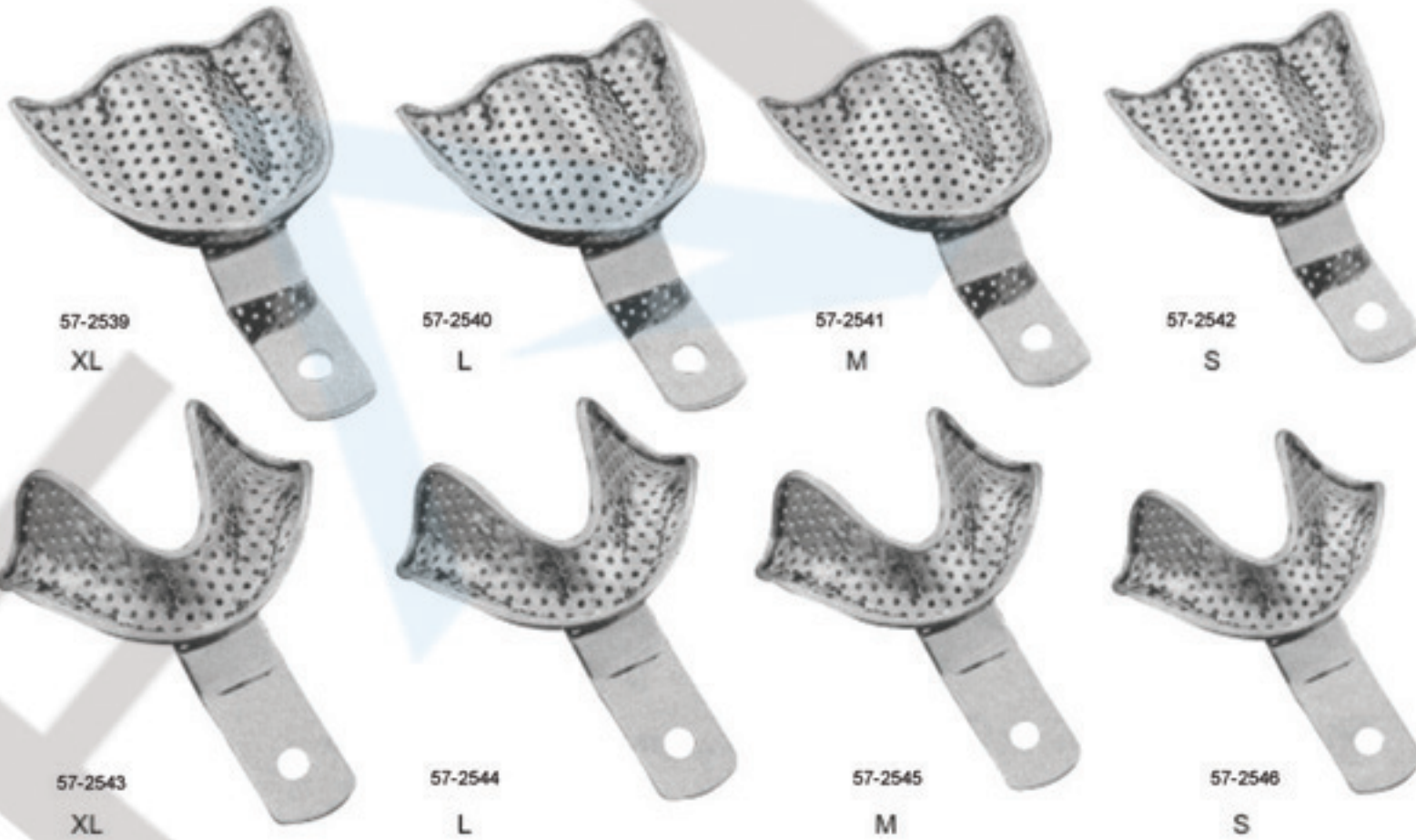
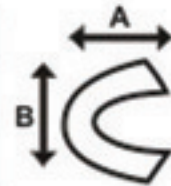

Perforated Full Denture Set of 8

Made of 18/8 Stainless Steel, Solid Set of 6



IMPRESSION

All The Above Impression Trays are Available in These 4 Sizes

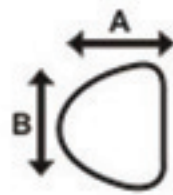

UPPER		U1	U2	U3
	A	67	64	57
B	81	71	70	

All Dimension are in mm

LOWER		L1	L2	L3
	A	60	57	54
B	81	79	76	

All Dimension are in mm



Perforated Set of 6

Made of 18/8 Stainless Steel, English Pattern Set of 8



57-2559
Lower



57-2560
Upper

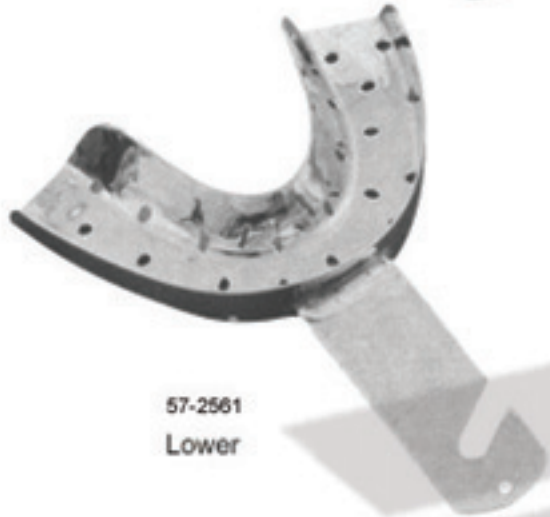

57-2561
Lower



57-2562
Upper

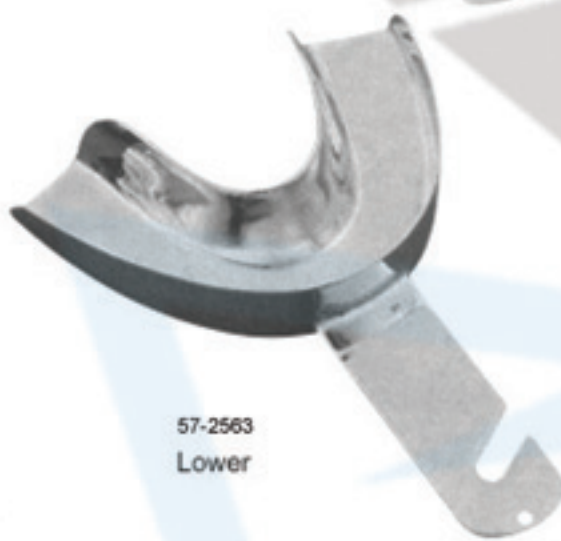

57-2563
Lower



57-2564
Upper

All The Above Impression Trays are Available in These 4 Sizes

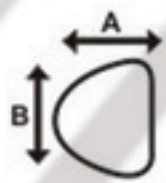

UPPER	Size	A	B	C
	0	67	50	12
	1	72	51	13
	2	78	55	15
	3	80	58	15

All Dimension are in mm

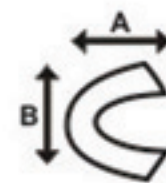

LOWER	Size	A	B	C
	0	70	50	14
	1	77	51	15
	2	79	55	15
	3	80	60	17

All Dimension are in mm

Made of 18/8 Stainless Steel, Solid Full Denture Set of 8

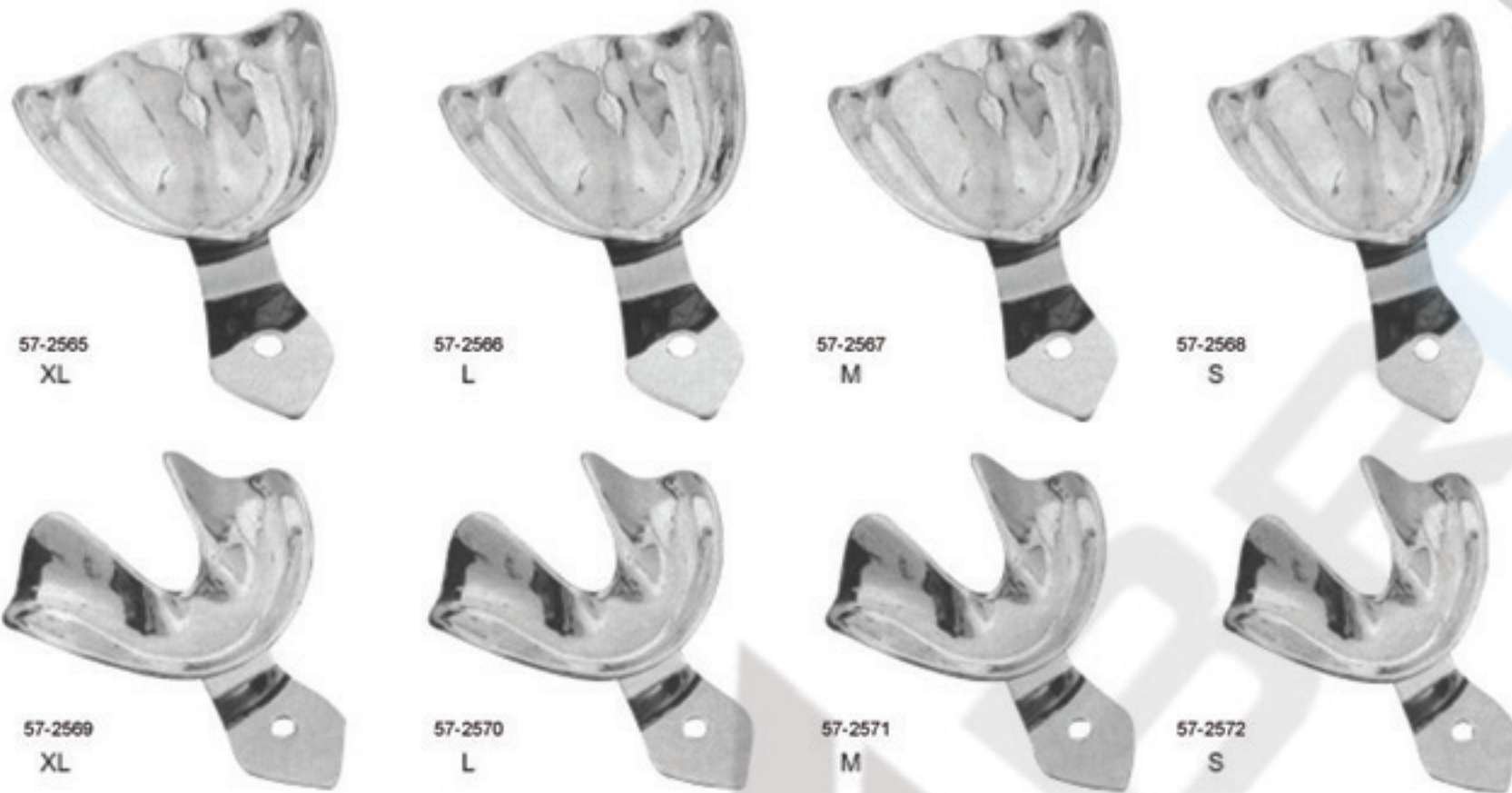

All The Above Impression Trays are Available in These 4 Sizes

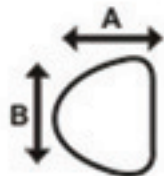

UPPER		XL	L	M	S
	A		70	67	64
B		79	76	70	73

All Dimension are in mm

LOWER		XL	L	M	S
	A		64	64	60
B		86	70	73	70

All Dimension are in mm

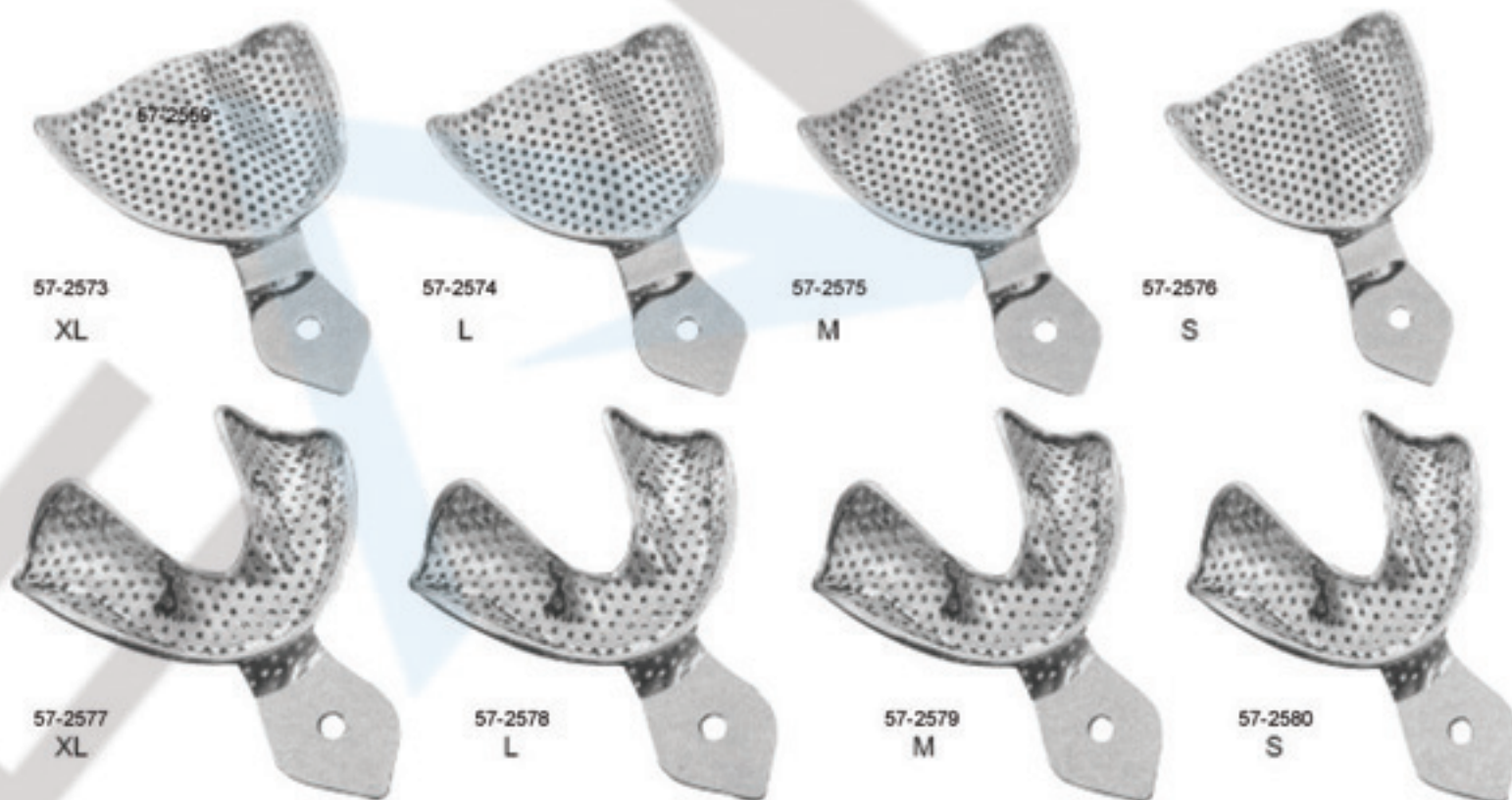

Made of 18/8 Stainless Steel, Perforated Full Denture Set of 8

Made of 18/8 Stainless Steel, Solid Full Denture Set of 8



IMPRESSION



57-2581
U0



57-2582
U1



57-2583
U2



57-2584
U3



57-2585
L0



57-2586
L1



57-2587
L2



57-2588
L3

Upper Sizes: 0,1,2,3
Depth of Tray: 15,9 mm, Height of Plate: 12,5 mm

Lower Sizes: 0,1,2,3
Depth of Tray: 12,9 mm



57-2589
U0

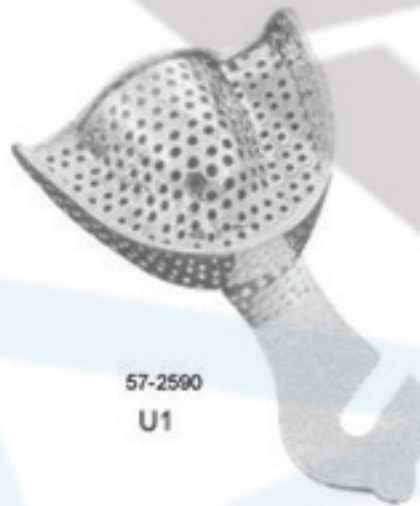

57-2590
U1



57-2591
U2



57-2592
U3



57-2593
L0



57-2594
L1

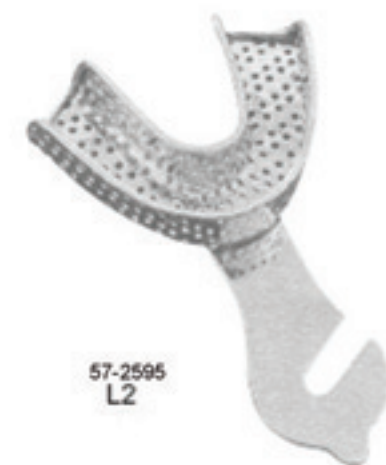

57-2595
L2



57-2596
L3

Made of 18/8 Stainless Steel, Perforated Full Denture Set of 8