

58

**SURGICAL**

PAGE 135 - 166

**FAM**BRO®



**NAME OF QUALITY INSTRUMENTS**



No. 3  
12 cm / 4 6/8"  
58-3001



No. 3  
12 cm / 4 6/8"  
58-3002



No. 4  
with scale  
12 cm / 4 6/8"  
58-3003



No. 4  
12 cm / 4 6/8"  
58-3004



No. 7  
16 cm / 6 2/8"  
58-3005



No. 7K  
12.5 cm / 4 7/8"  
58-3006



Beaver Handle  
Solid 5"  
58-3007



No. 5  
58-3008



No. 5A  
58-3009



No. 3L  
58-3010



No. 3L  
Angled  
58-3011



Beaver Handle  
Solid 5"  
58-3012



Beaver Handle  
Solid 5"  
58-3013



No. 10  
58-3014



No. 11  
58-3015



No. 12  
58-3016



No. 13  
58-3017



No. 15  
58-3018



No. 16  
58-3019



No. 17  
58-3020



No. 18  
58-3021



No. 19  
58-3022



No. 20  
58-3023



No. 21  
58-3024



No. 22  
58-3025



No. 23  
58-3026



No. 24  
58-3027



No. 34  
58-3028



No. 36  
58-3029



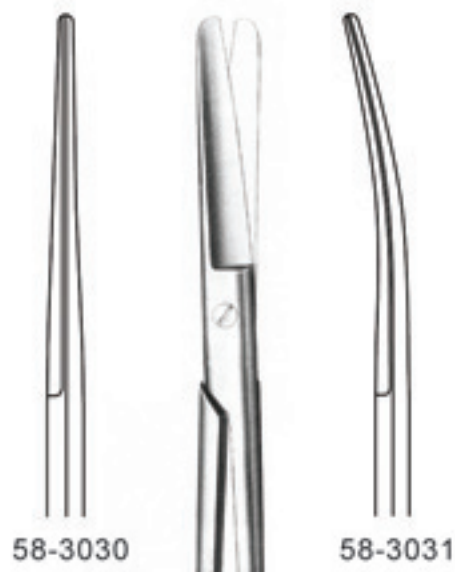

58-3030

58-3031



Operating Scissor  
14.5 cm/5 6/8"  
blunt/blunt



58-3032

58-3033



Operating Scissor  
14.5 cm/5 6/8"  
sharp/blunt

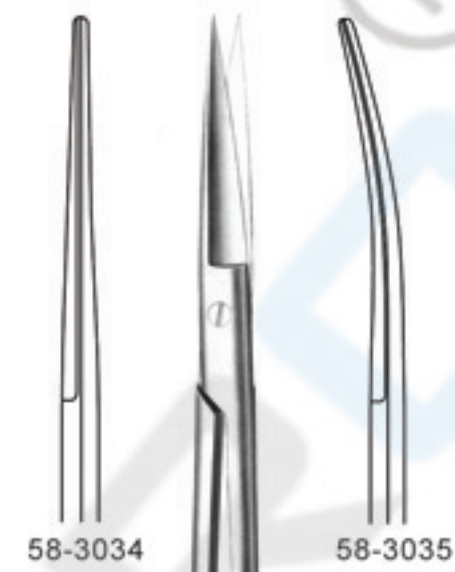

58-3034

58-3035



Operating Scissor  
14.5 cm/5 6/8"  
sharp/sharp



Mayo  
Blunt/Blunt  
14.5 cm/5 6/8"  
58-3036

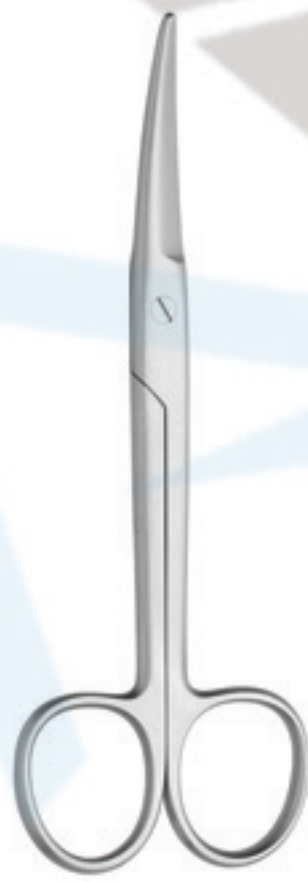

Mayo  
Blunt/Blunt  
14.5 cm/5 6/8"  
58-3037



Kelly  
16 cm/6 1/4"  
58-3038  
Str



Kelly  
16 cm/6 1/4"  
58-3039  
Cvd



Quinby  
Curved  
12.5cm/5"  
58-3040



Dean  
16.5cm/6"  
58-3041



Locklin Curved  
16cm/6 1/4"  
58-3042



Locklin  
16cm/6 1/4"  
58-3043



LaGrange  
Double-Curved  
11.5cm/4 1/2"  
58-3044



Sullivan  
14cm/5"  
58-3045



Goldman-Fox  
12.5cm/5"  
58-3046



Strabismus  
Straight  
Tenotomy  
11.5cm/4"  
58-3047



Joseph  
Straight  
14cm/5"  
58-3048



Joseph  
Curved  
14cm/5"  
58-3049



Iris  
Straight  
11.5cm/4 1/2"  
58-3050



Iris  
Curved  
11.5cm/4 1/2"  
58-3051



Metzenbaum  
Straight  
14.5cm/5 1/4"  
58-3052

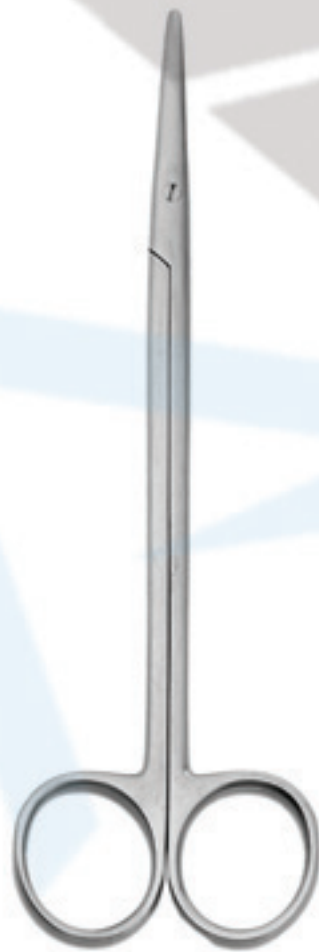

Metzenbaum  
Curved  
14.5cm/5 1/4"  
58-3053



Metzenbaum-Baby  
Straight  
12.5cm/5"  
58-3054



Metzenbaum-Baby  
Curved  
12.5cm/5"  
58-3055



Suture  
58-3056 12cm/4 3/4"  
58-3057 15cm/6"



Wagner  
Straight  
11.5cm/4 1/2"  
58-3058



Wagner  
Curved  
11.5cm/4 1/2"  
58-3059



Wagner  
Angled  
11.5cm/4 1/2"  
58-3060



Crown & Gold  
Straight  
12cm/4 3/4"  
58-3061



Crown & Gold  
Curved  
12cm/4 3/4"  
58-3062



Wire Cutting Scissor  
12.5cm/5"  
58-3063



Lister  
Bandage  
14.5cm/5 3/4"  
58-3064



14.5cm/5 3/4"  
58-3065



Castroviejo  
Curved  
10cm/4"  
58-3066





Metzenbaum  
Straight/Blunt  
14.5cm/5 1/2"  
58-3067



Metzenbaum  
Curved/Blunt  
14.5cm/5 1/2"  
58-3068



Metzenbaum  
Straight/Pointed  
14.5cm/5 1/2"  
58-3069



Metzenbaum  
Curved/Pointed  
14.5cm/5 1/2"  
58-3070



Metzenbaum  
Delicate  
Curved/Blunt  
18cm/7"  
58-3071



Goldman-Fox  
Straight  
13cm/5"  
58-3072



Goldman-Fox  
Curved  
13cm/5"  
58-3073



Wire Cutting  
12cm/4"  
58-3074



Iris  
Straight  
11.5cm/4"  
58-3075



Iris  
Curved  
11.5cm/4"  
58-3076



Dean  
16.5cm/6"  
58-3077



Locklin  
Curved Handle  
16.5cm/6"  
58-3078



Locklin  
16.5cm/6"  
58-3079

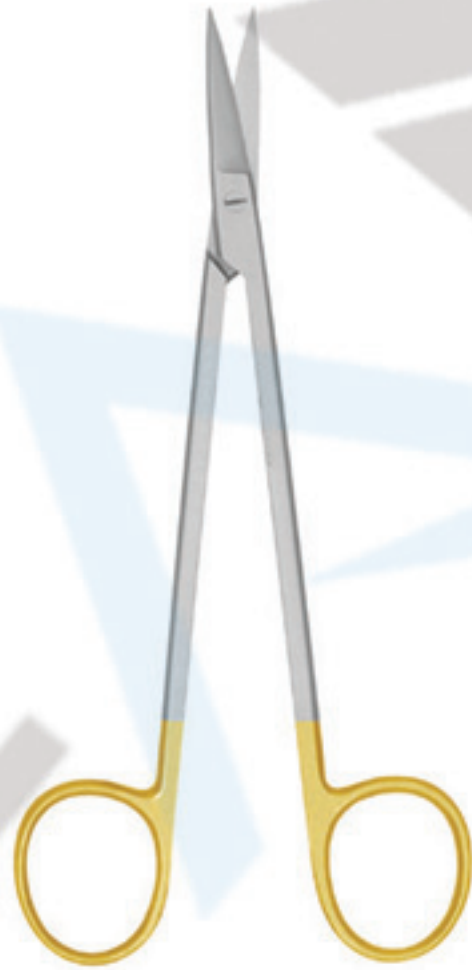

Kelly  
Straight  
16cm/6"  
58-3080

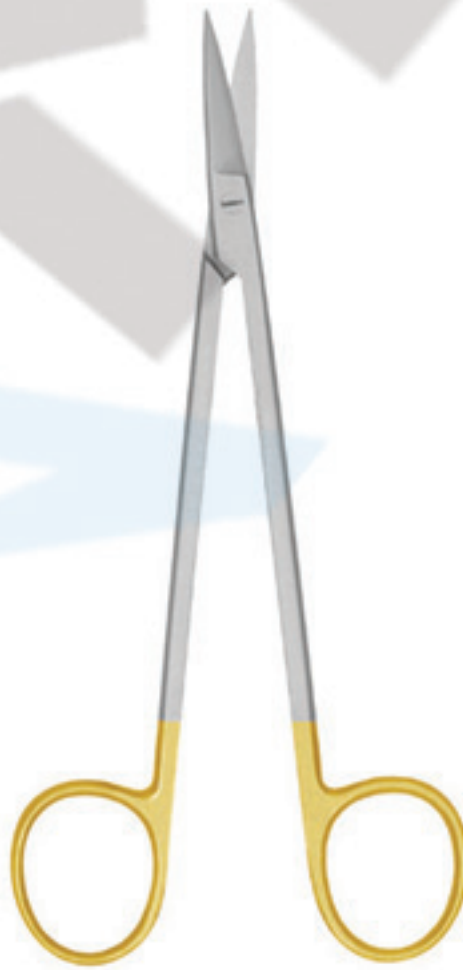

Kelly  
Curved  
16cm/6"  
58-3081



Metzenbaum  
14.5cm/5.5"  
58-3082



58-3083  
College  
15 cm



smooth



58-3084  
College  
15 cm



serrated



58-3085  
College  
15 cm



smooth



58-3086  
College  
15 cm



serrated



58-3087  
College  
15 cm



smooth



58-3088  
College  
15 cm



serrated



58-3089  
College  
15 cm



smooth



58-3090  
College



serrated

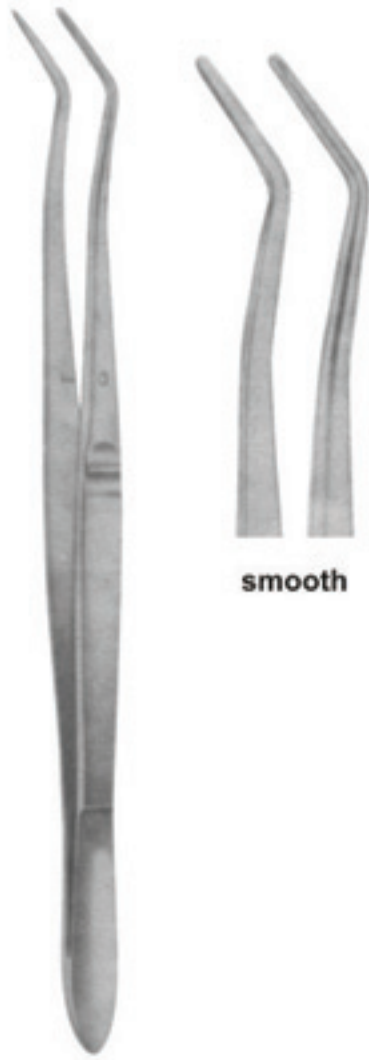

smooth

58-3091  
Meriam  
16 cm

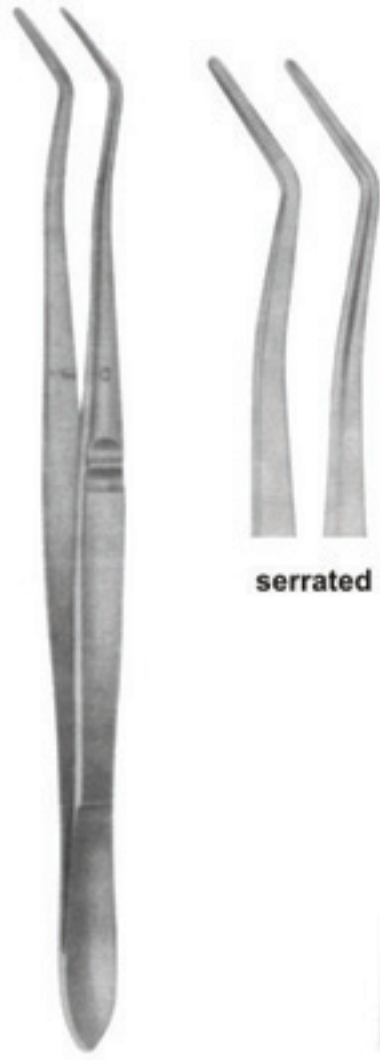

serrated

58-3092  
Meriam  
16 cm

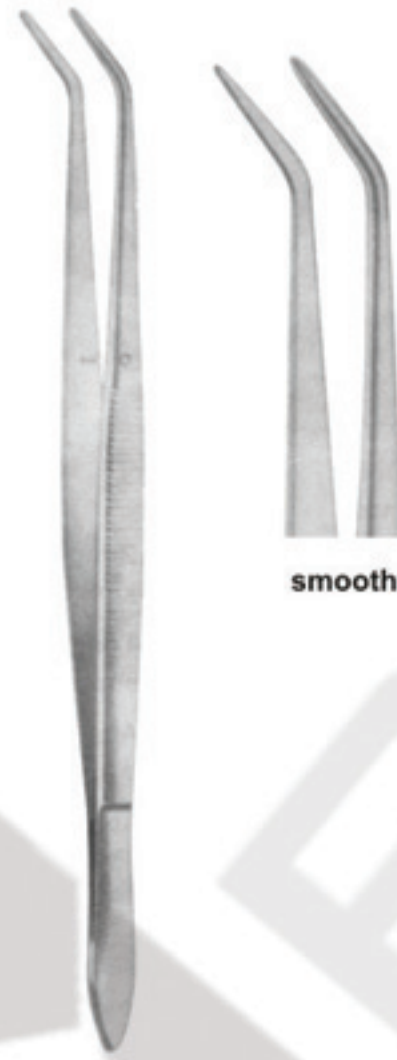

smooth

58-3093  
Meriam  
16 cm

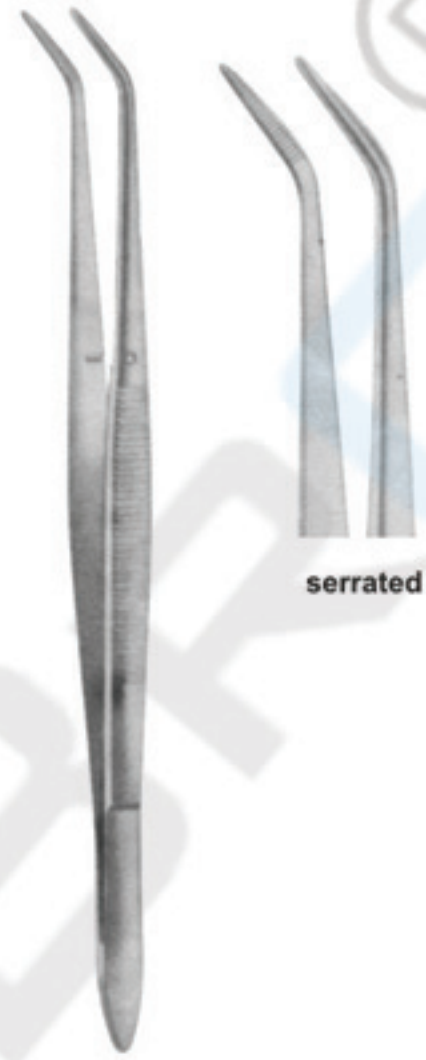

serrated

58-3094  
Meriam  
16 cm

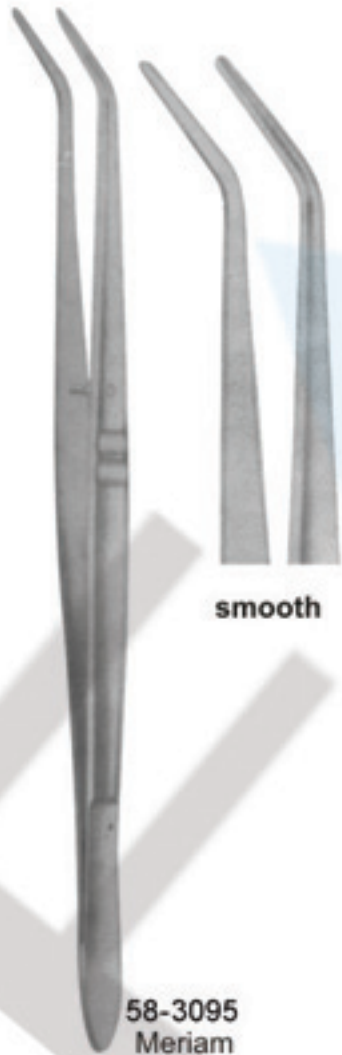

smooth

58-3095  
Meriam  
16 cm

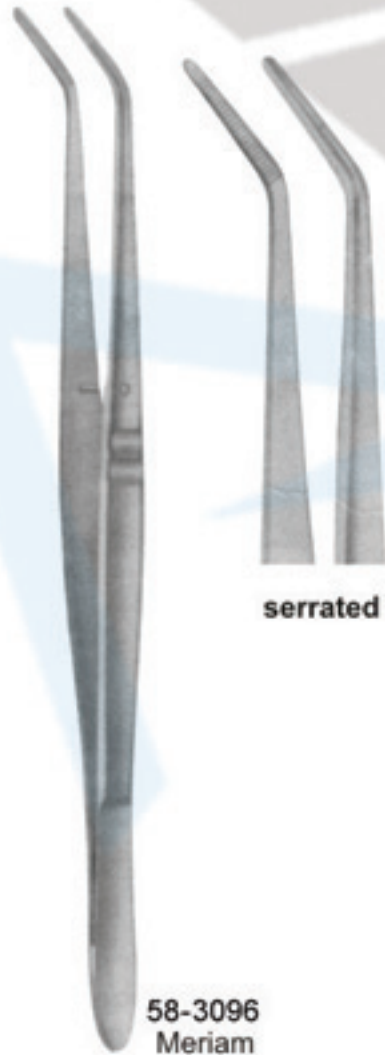

serrated

58-3096  
Meriam  
16 cm

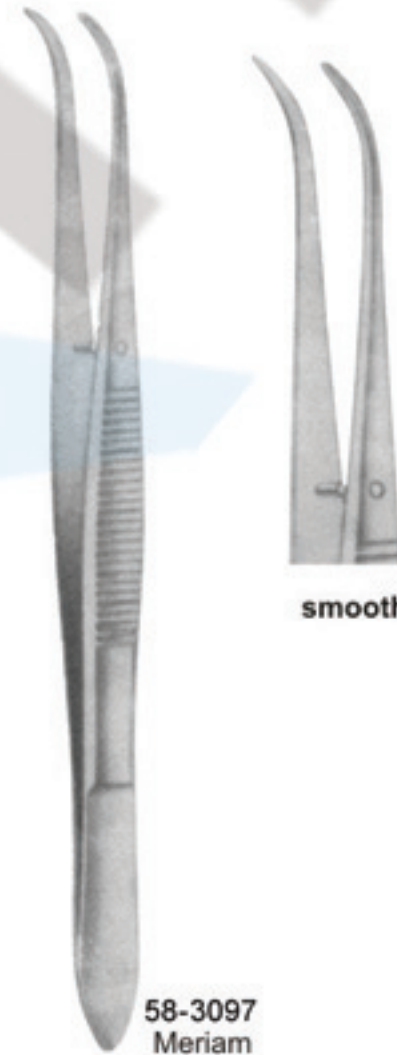

smooth

58-3097  
Meriam  
16 cm

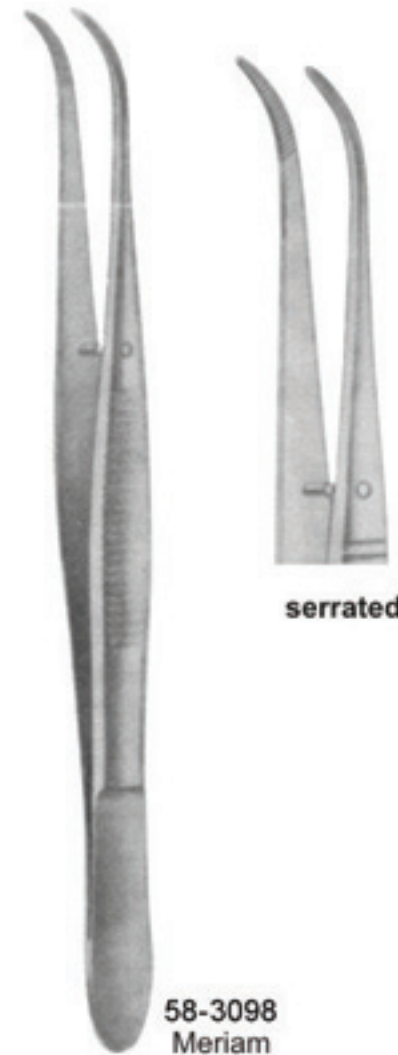

serrated

58-3098  
Meriam  
16 cm





58-3099  
Mayo-Hegar  
16 cm



58-3100  
Mayo-Hegar TC  
16 cm



58-3101  
Mayo-Hegar  
18 cm



58-3102  
Mayo-Hegar TC  
18 cm



58-3103  
Mini-Ryder  
18 cm



58-3104  
Mini-Ryder  
15 cm



58-3105  
Derf  
12 cm



58-3106  
Hegar-Baumgarther  
14 cm



58-3107  
Crile-Wood  
15 cm



58-3108  
Crile-Wood TC  
15 cm



58-3109  
Adson  
17.5 cm



58-3110  
Olsen-Hegar  
14 cm



58-3111  
Baumgarther  
14.5 cm



58-3112  
Gillies  
16 cm



58-3113  
Gillies  
16 cm



58-3114  
Hegar-Baumgarther  
14 cm



58-3115  
Toennis  
18 cm



58-3116  
Toennis  
18 cm



58-3117  
Lichtenberg  
17 cm



58-3118  
Lichtenberg  
17 cm



58-3119  
Eiselberg-Mathieu  
19.5 cm



58-3120  
Boynton  
12 cm



58-3121  
Arruga  
16 cm



58-3122  
Boynton  
12 cm



58-3123  
Arruga  
16 cm



**58-3140**  
Castroviejo  
14 cm



**58-3141**  
Castroviejo  
14 cm



**58-3142**  
Castroviejo  
14/60 cm



**58-3143**  
Castroviejo  
18 cm



**58-3144**  
Castroviejo  
18 cm



**58-3145**  
Castroviejo  
14 cm



**58-3146**  
Castroviejo  
14 cm



**58-3147**  
Castroviejo  
14/60 cm



**58-3148**  
Castroviejo  
18 cm



**58-3149**  
Castroviejo  
18 cm





58-3150  
Mathieu  
14 cm



58-3151  
Mathieu  
14 cm



58-3152  
Mathieu  
14 cm



58-3153  
Mathieu  
14 cm



58-3154  
Mathieu  
17 cm



58-3155  
Mathieu  
17 cm



58-3156  
Mathieu  
14 cm



58-3157  
Micro-Barraquer  
18 cm



The tips have tungsten carbide inserts for better handling.



58-3175  
Mathieu  
17 cm



58-3176  
Mathieu  
17 cm



58-3177  
Micro-Barraquer  
14 cm



58-3178  
Castroviejo  
13 cm



58-3179  
Castroviejo-Barraquer  
13 cm



58-3180  
Castroviejo  
13 cm



58-3181  
Castroviejo  
13 cm



18.03mm,cm

58-3182  
Fig. 12FR  
Fraizer



18.04mm,cm

15.04mm,cm



18.05mm,cm

58-3183  
Fig. 10FR  
Fraizer

15.03,3mm,cm



58-3185  
Fig. 6FR  
Fraizer  
15.02mm,cm

58-3184  
Fig. 8FR  
Fraizer

15.02,7mm,cm



58-3186 Aspirating Syringe

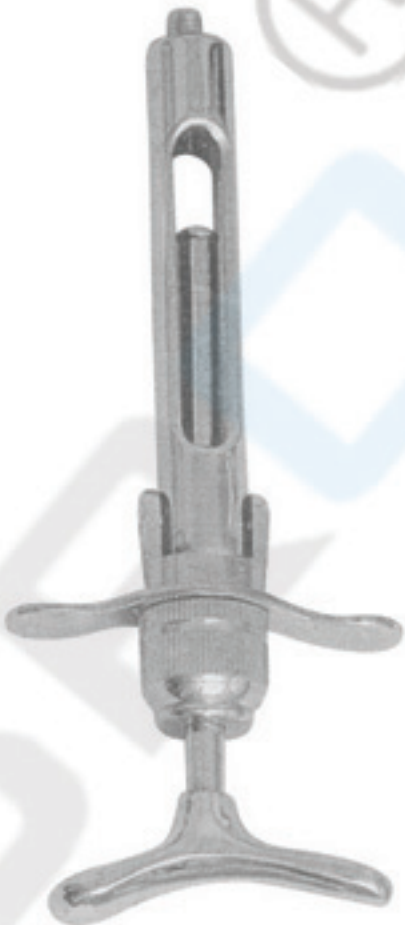

58-3190 Breech Loading Syringe

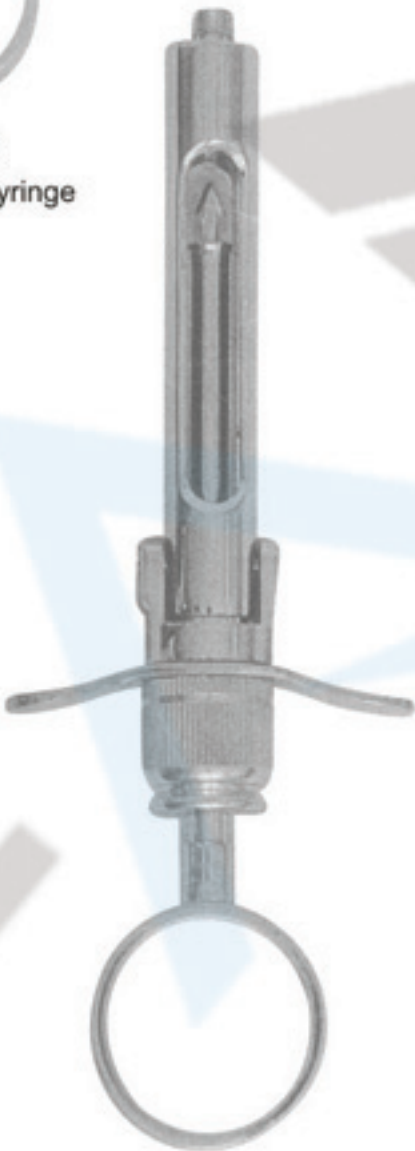

58-3187 Aspirating & Breech Syringe



58-3188 Band Adaptor



58-3189 Endo Finger Ruler With Adjustable Slide



58-3191 Aspirating Syringe

SURGICAL



58-3192



58-3193



58-3194

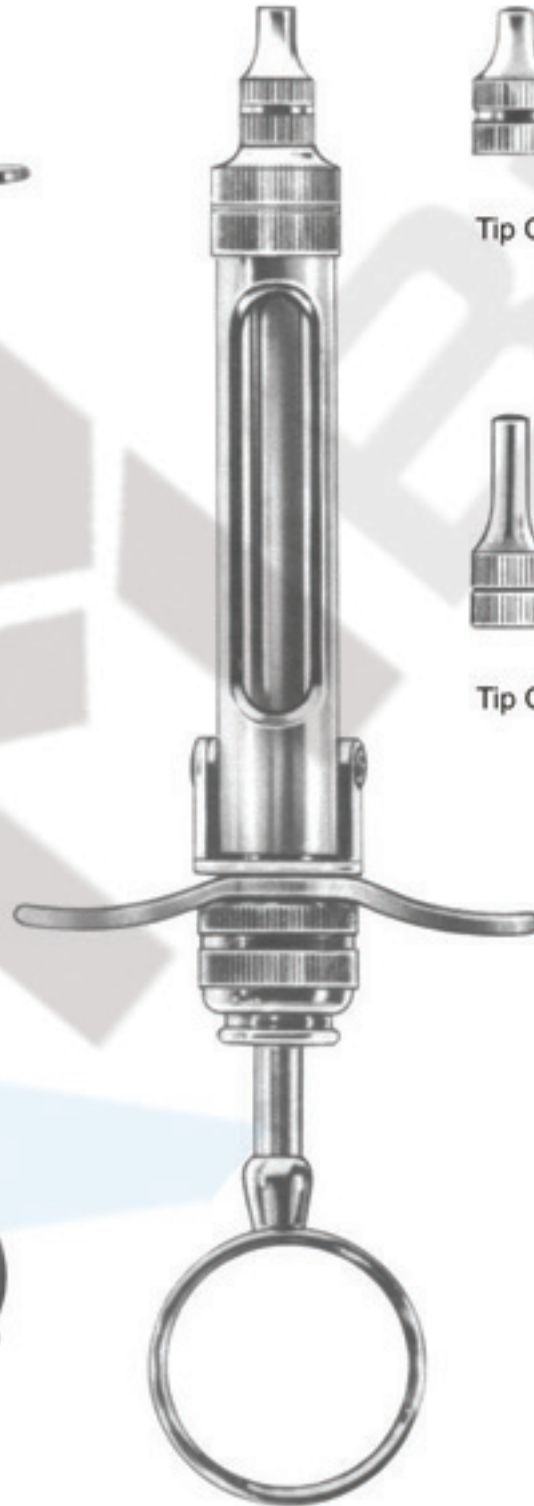

58-3196/1,8 ml  
58-3197/2,2 ml

Cartridge Syringe complete  
With 2 tips and without needles



Tip Only, short



Tip Only, long

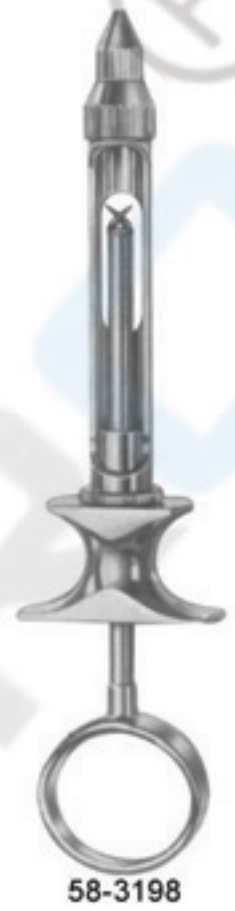

58-3198



58-3195



58-3199



58-3200  
Cork screw tip



58-3201  
Cork screw tip



58-3203  
Folding type, cork  
screw tip



58-3204  
Folding type, cork  
screw tip



58-3205  
Cork screw tip



58-3208  
Autoclavable Plastic Protection sleeve



58-3206  
Spare cap with  
metric thread



58-3207  
With Whitworth  
thread



58-3209  
Brass syringe with stainless steel moving parts



58-3210  
Brass syringe with stainless  
steel moving parts



58-3211  
140 mm

58-3212  
BRUENINGS  
190 mm

58-3213

58-3214

58-3215

58-3216

58-3217



58-3223



58-3218  
Mouth Gag with  
Tongue Depressor  
11.0 cm  
13.0 cm  
15.0 cm



58-3219  
Mouth Gag without  
Tongue Depressor  
11.0 cm  
13.0 cm  
15.0 cm



58-3220  
Jennings, Mouth Gag  
11.0 cm  
13.0 cm  
15.0 cm



58-3221



58-3222



58-3224  
DENHART



58-3225  
DENHART  
Mouth Gag With  
Silicon Inserts,  
Interchangeable  
Size: 125 mm

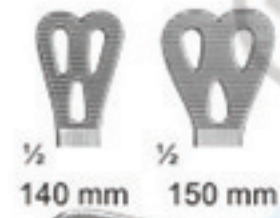

58-3227  
WIEDER  
Tongue depressor  
140mm  
150mm



58-3226  
TOBOLD  
Tongue depressor  
Size: 145 mm



58-3231  
ANDREW  
Tongue depressor  
Size: 110 mm

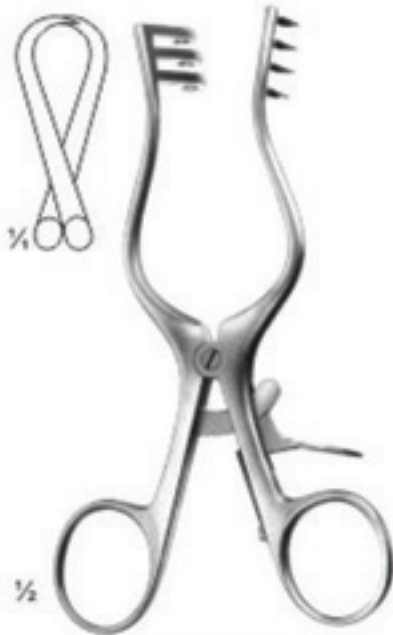

58-3228  
WEITLANER  
Sharp  
130 mm

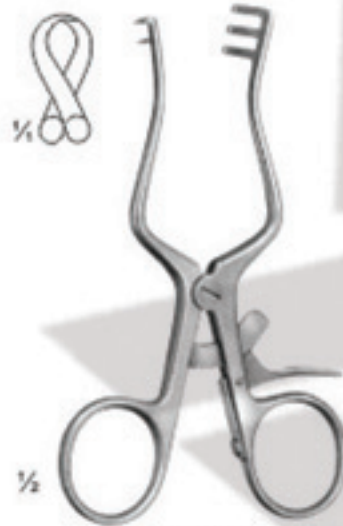

58-3229  
WEITLANER  
Sharp  
110 mm



58-3230  
WEITLANER  
Semi-Sharp  
110 mm



58-3232  
MOLT  
Pediatric



58-3233  
MOLT  
Child



58-3234  
MOLT  
Adult



58-3235  
FERGUSON-ACKLAND  
Mouth Gag  
Size: 145 mm



58-3236  
ROSER KOENIG  
Mouth Gag  
Size: 160mm / 185mm



58-3237  
Fig. 1B  
165 mm

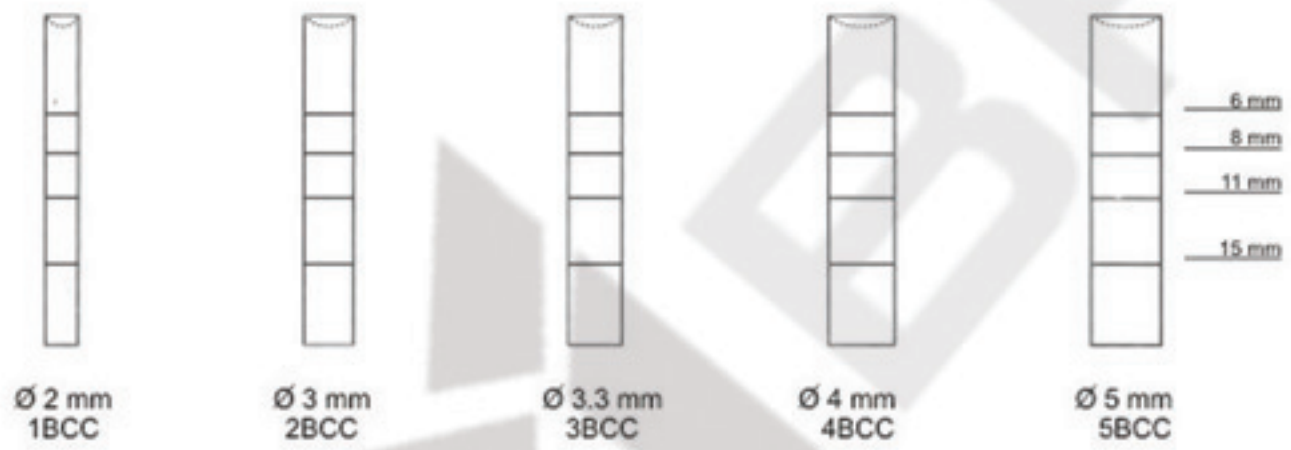
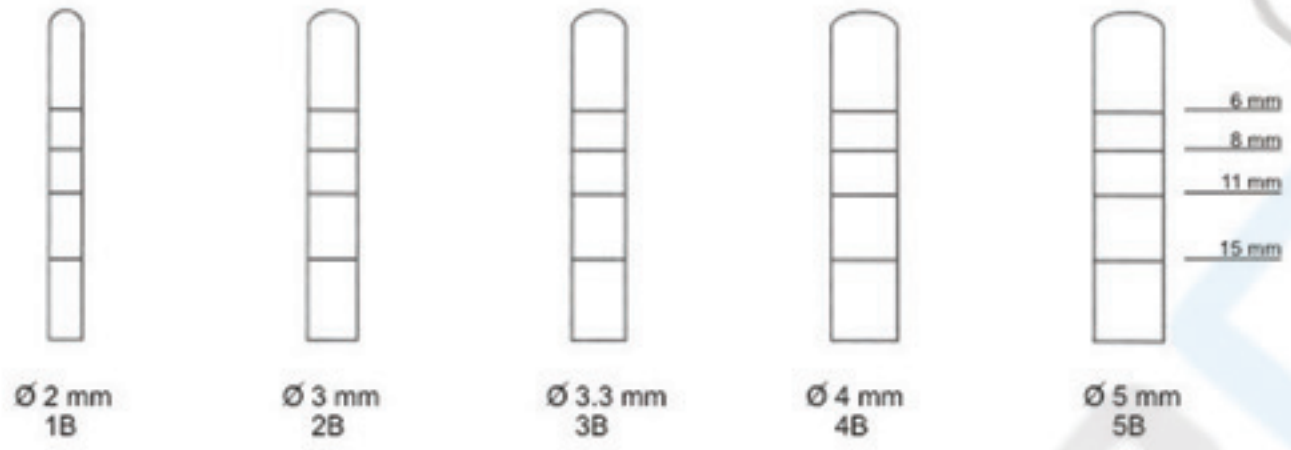

58-3238  
Fig. 1  
155 mm

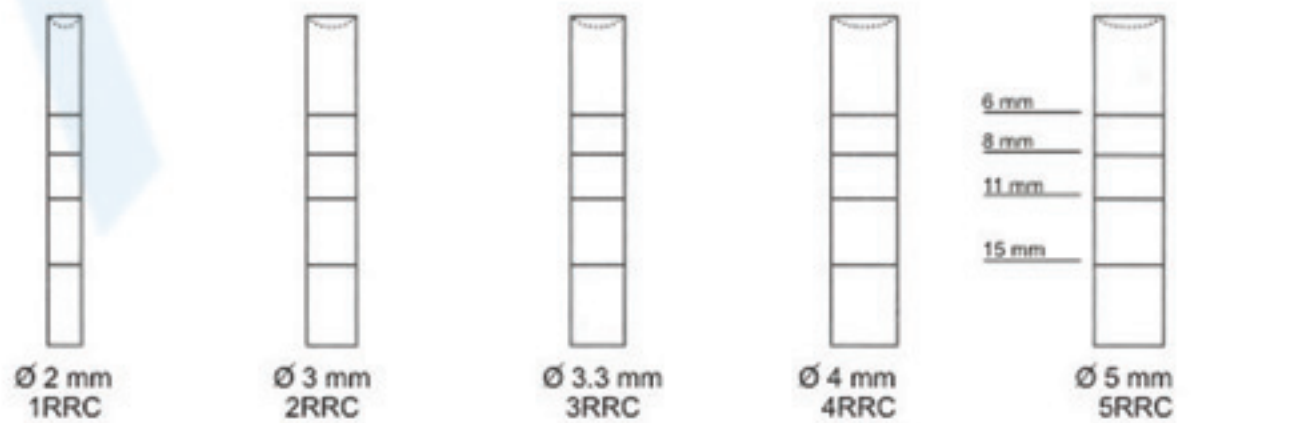
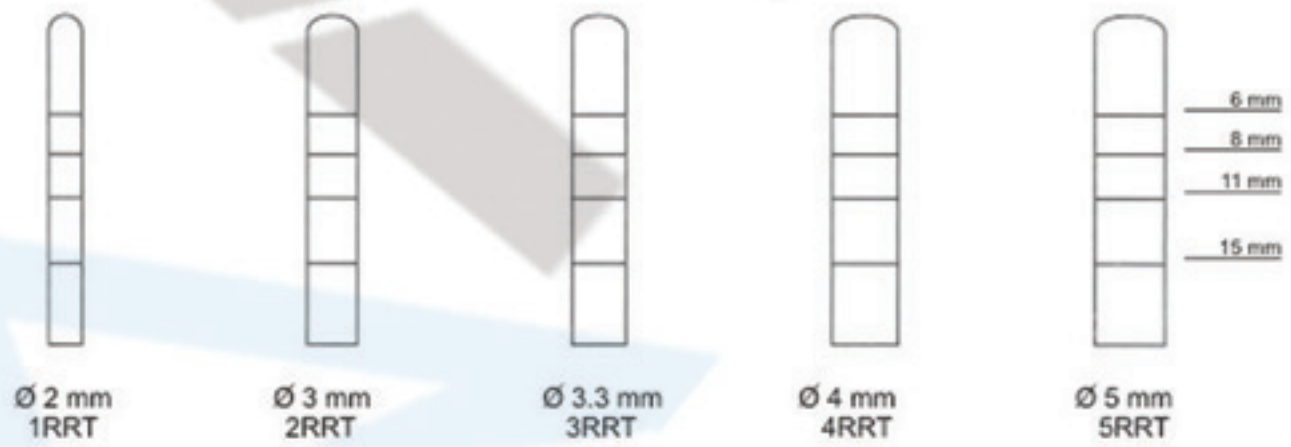





58-3239  
1P  
150 mm



1P  
150 mm



2P  
150 mm



3P  
150 mm

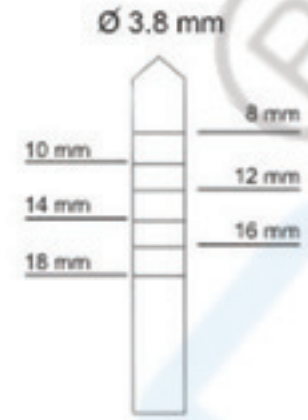

4P  
150 mm



1T  
150 mm



2T  
150 mm



3T  
150 mm



58-3240  
Fig. 1  
155 mm



1  
155 mm



2  
155 mm



3  
155 mm



4  
155 mm



5  
155 mm



6  
155 mm



**58-3241**  
Plaster Shear  
210 mm

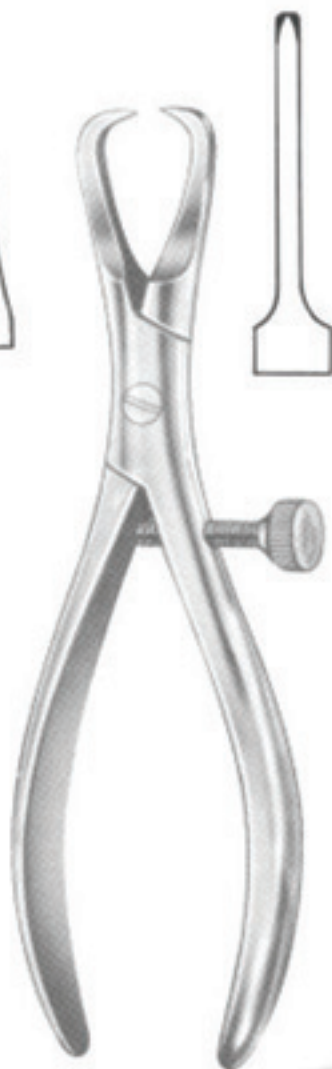

**58-3242**  
Crown Removing Plier  
14 cm



**58-3243**  
MONTFORT  
18 CM



**58-3244**  
BOHM  
16 cm



**58-3245**  
Telescope Crown  
Plier, Diamond coated  
13.0 cm



**58-3246**  
Telescope Crown  
Plier, Diamond coated  
13.0 cm



**58-3247**  
Telescope Crown Plier  
13.0 cm gerieften Maul  
15.0 cm gerieften Maul  
13.0 cm gelatts Maul  
15.0 cm gelatts Maul



**58-3248**  
Telescope Crown  
Plier, Fine  
15.0 cm



**Keramogrip Forceps Straight**

58-3249



**Jacket Grip Tweezer**

58-3250

Endo guns for retrograds.

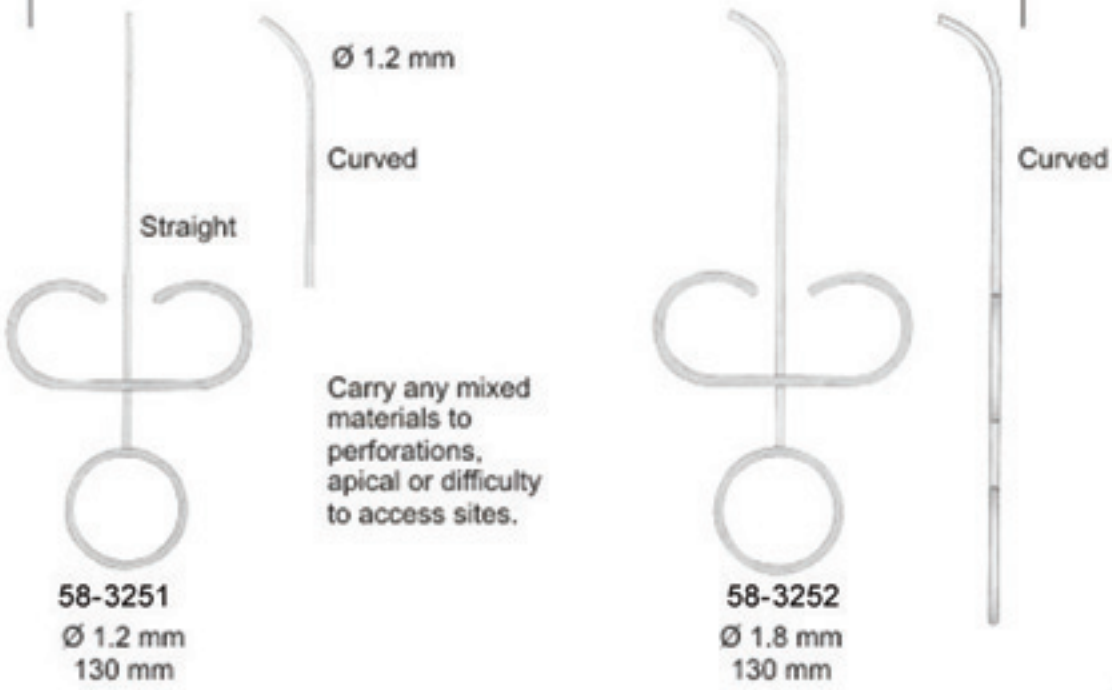

Bone Injectors

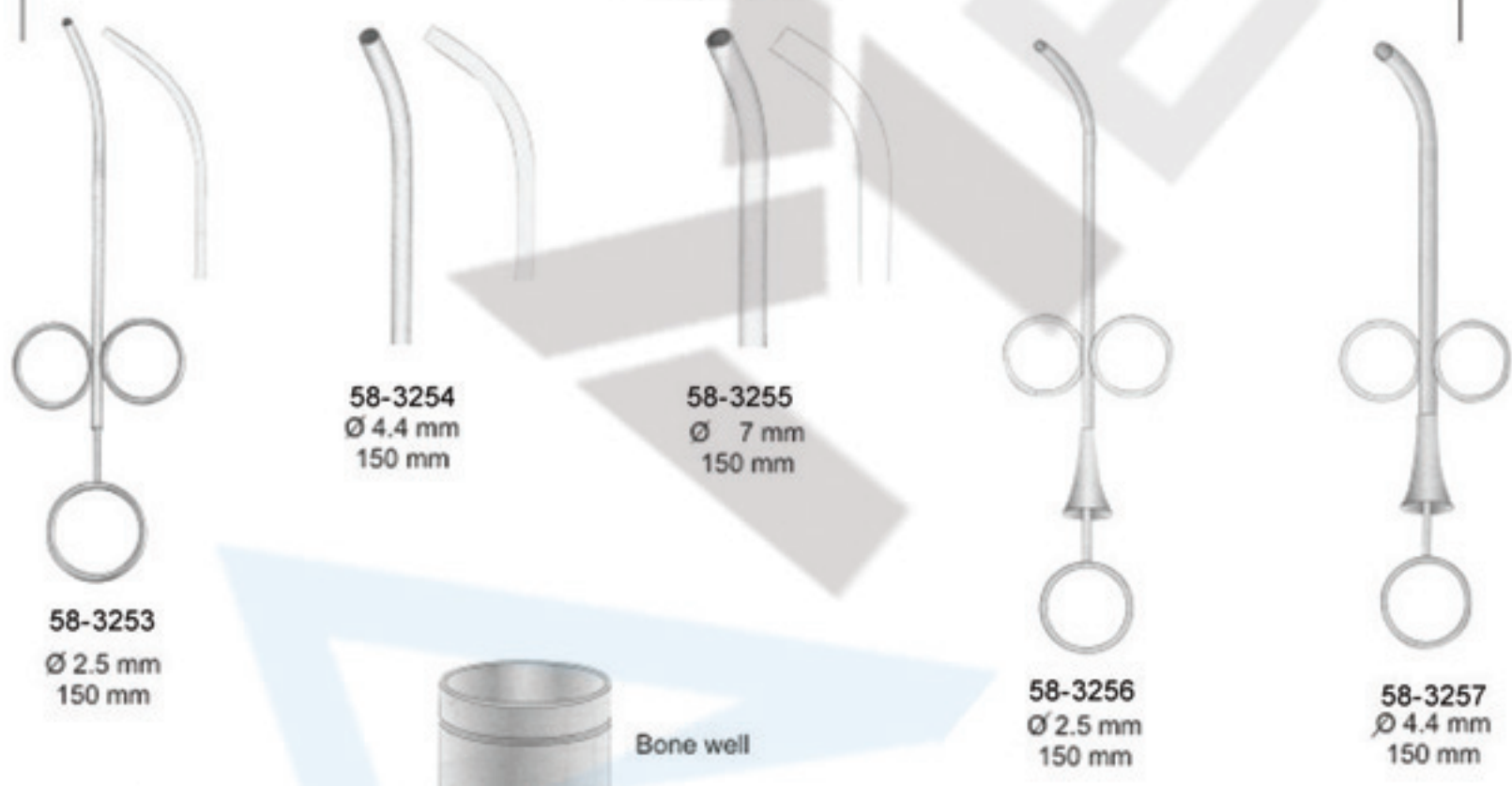

58-3258  
Ø 35 mm  
h 35 mm

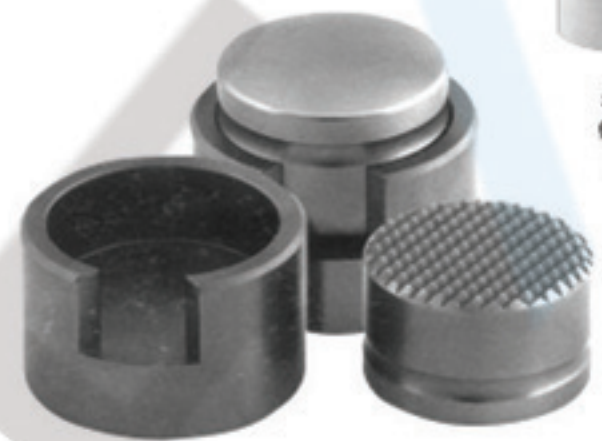

58-3259  
Grinders for autogenous



58-3260  
Bone Mill Forcep  
17.0 cm

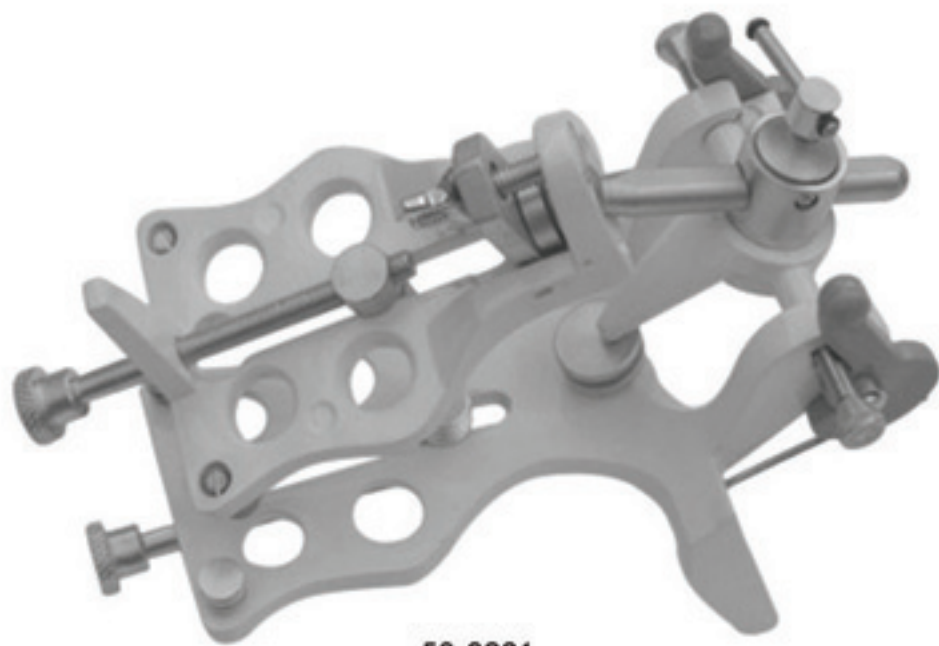

58-3261



58-3262



58-3263



58-3264



58-3265



58-3266



58-3267



58-3268

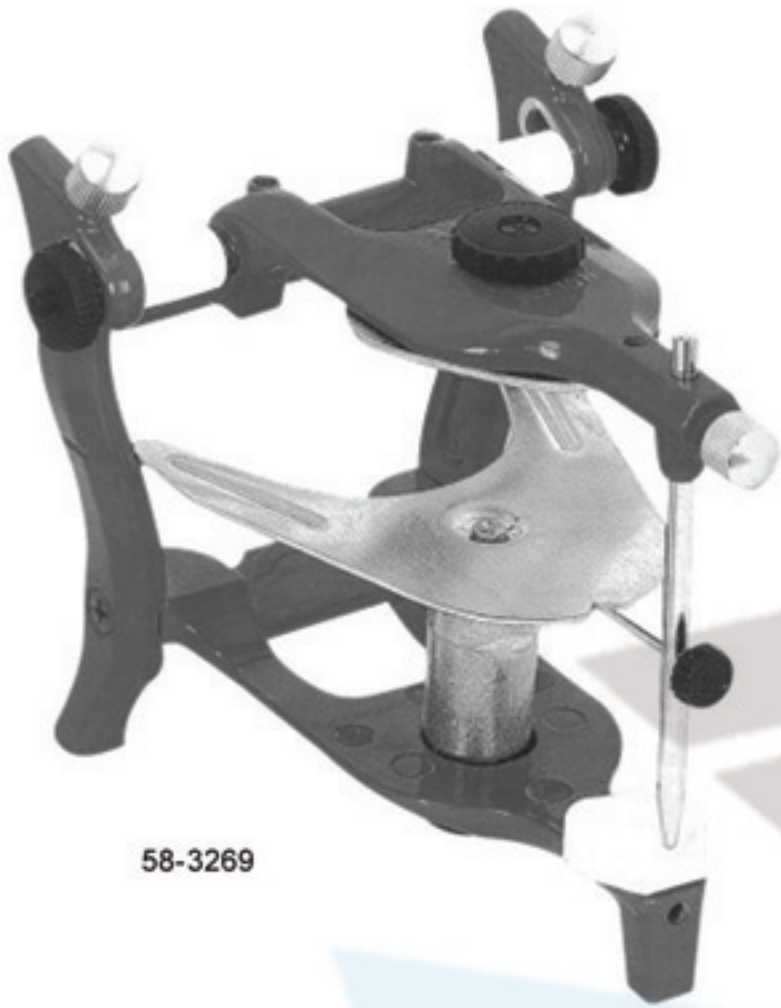

58-3269



58-3270



58-3271



58-3272



58-3274



58-3273



58-3275  
Instruments Tray of 20 Pcs

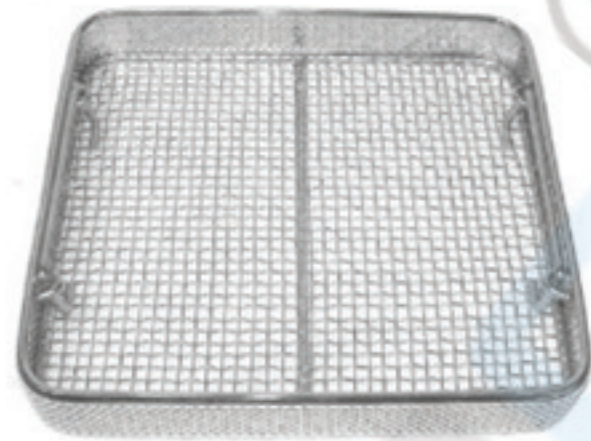

58-3276  
Instruments Riddle



58-3277  
Instruments Tray of 7 Pcs



58-3278  
Instruments Tray of 10 Pcs



58-3279  
Instruments Tray of 5 Pcs

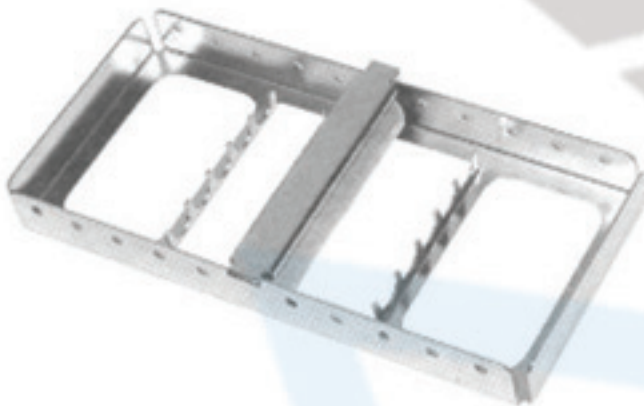

Instruments Tray of 5 Pcs  
58-3280

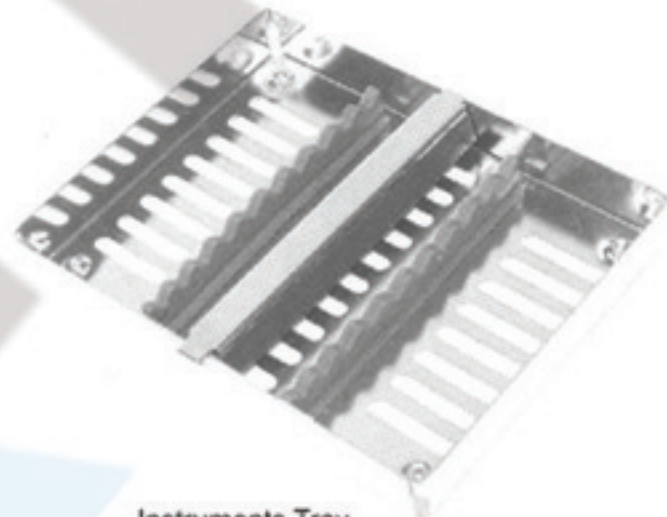

Instruments Tray  
58-3281



Instruments Tray  
Perforated  
58-3282



Instruments Tray  
Perforated Base  
58-3283



Instruments Tray  
Solid Base  
58-3284





58-3285  
Instruments Box



58-3286  
Instruments Box



58-3287  
Instruments Box



58-3288  
Instruments Sterilizer  
150x75 mm



58-3289  
Endodontic Box



58-3290  
Sterilizing Box  
320x120 mm



Instruments Tray  
58-3291



Instruments Tray  
58-3292



Instruments Tray  
(Perforated)  
58-3293



Instruments Tray  
Shallow(Mayo)  
58-3294



Scaler Tray  
20.0 x 10.0 x 1.5 cm  
58-3295

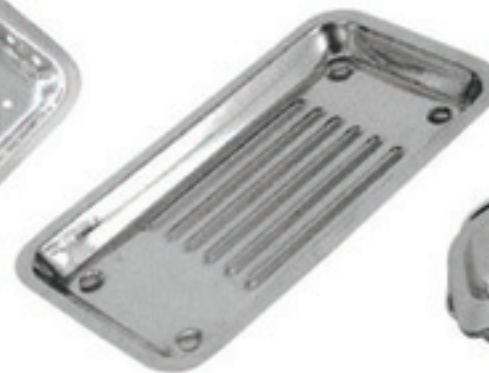

Scalers Tray  
58-3296



Scalers Tray  
58-3297